

10 Planen / Zubehör

1

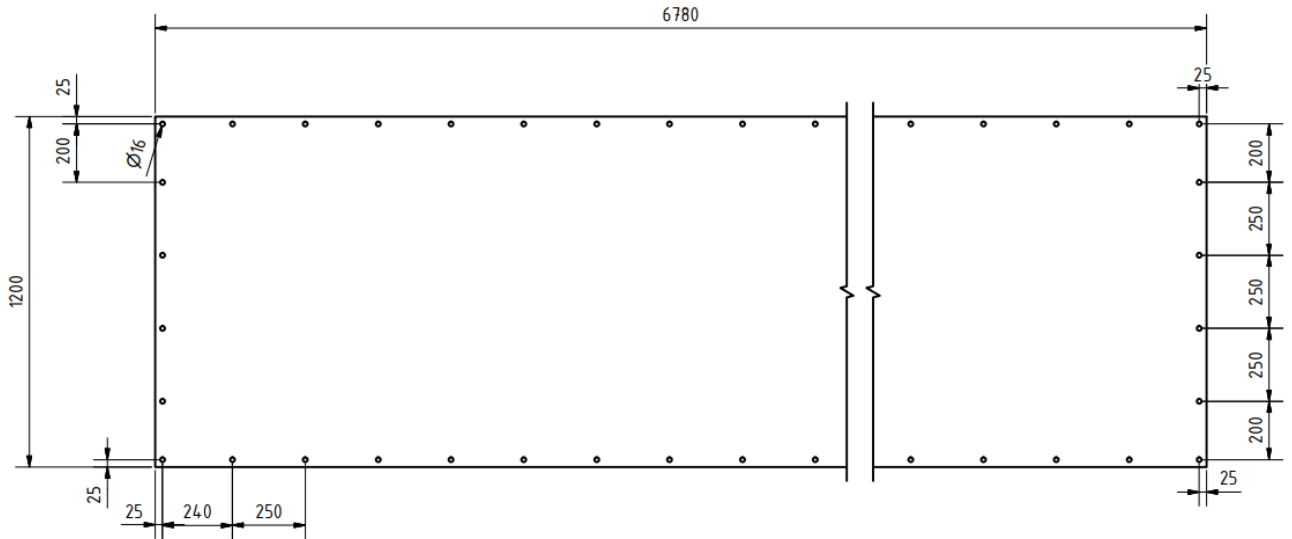

HW-KS-0011-02

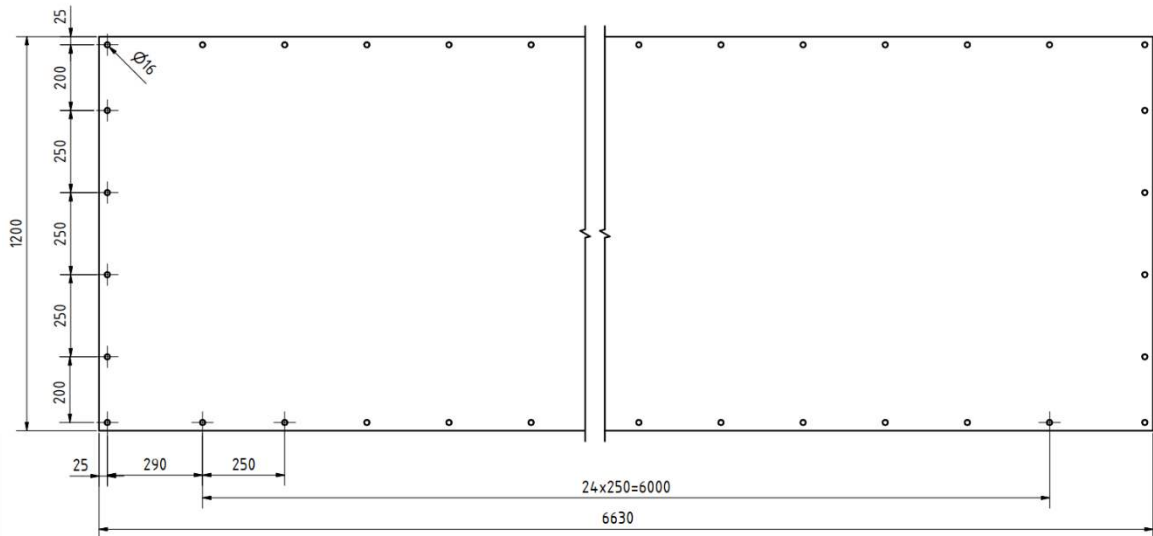

HW-KS-0011-09

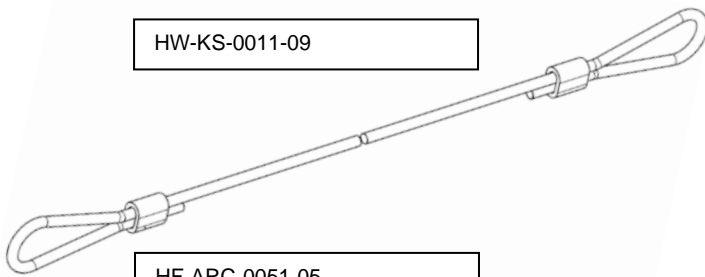

HF-ARC-0051-05

Längen	
1200 mm	6245 mm
3025 mm	6280 mm
4450 mm	6310 mm
5100 mm	6430 mm
5580 mm	6475 mm
5960 mm	

Zeich.-Nr.	Bezeichnung	Abmessung	Bemerkung	Gewicht/ Kg
HW-KS-0011-02	Gewebeplane / Netz	6780 x 1200 mm	Farbe: Schwarz / Grün	19,00
HW-KS-0011-09	Gewebeplane / Netz	6630 x 1200 mm	Farbe: Schwarz / Grün	18,00
HW-MT-0025-01	Spannschloss mit zwei Ösen		M8 DIN 1480	
HF-ARC-0051	Drahtseil mit Pressklemme	Ø 4mm	Länge bitte mit angeben	0,70
HW-MT-0045-01	Schraubnotglied	6 x 45 mm	verzinkt Mengeinheit 100 Stk.	

10 Planen / Zubehör

2

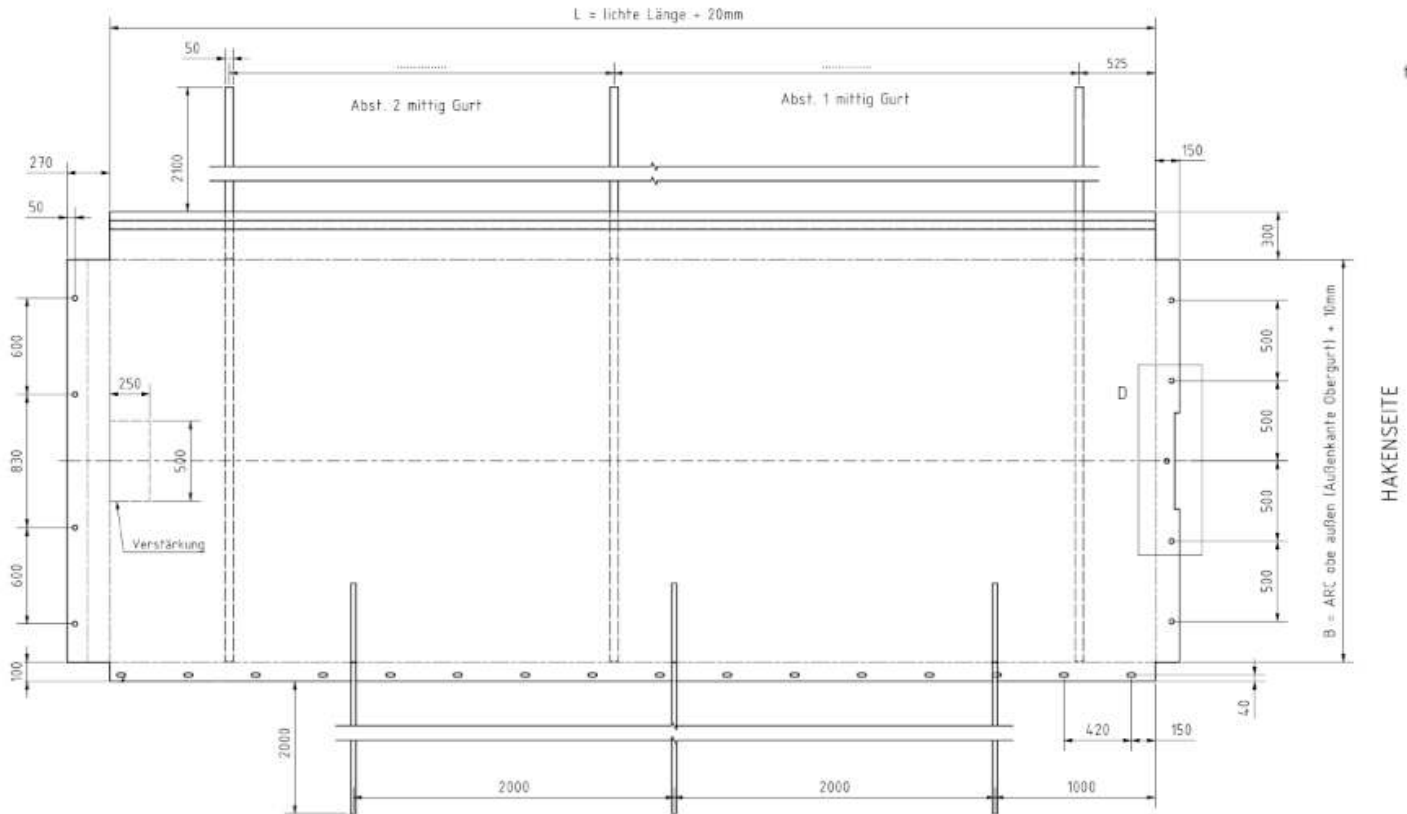

HW-KS-0018-01

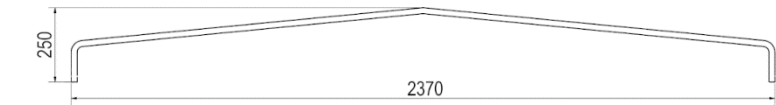

HF-ARC-0427-04

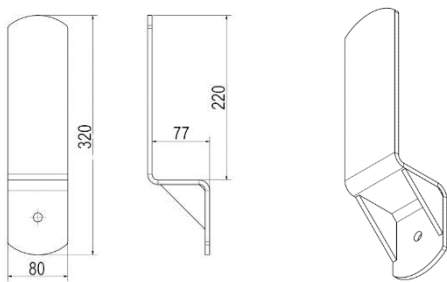

HF-ARC-0251-06

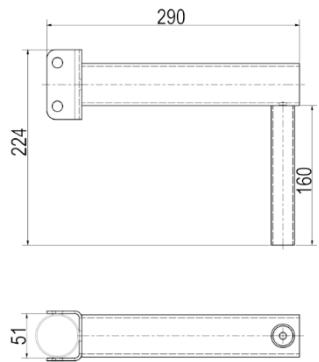

HF-ARC-0485-05

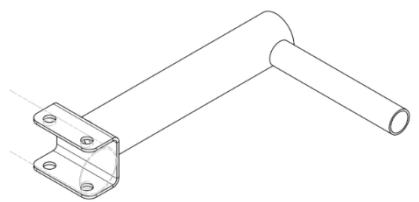

Zeich.-Nr.	Bezeichnung	Abmessung	Bemerkung	Gewicht/ Kg
HW-KS-0018-01	Rolllplane	Länge 6500-7000 mm	ab Höhe 1500 mm	76,00
HF-ARC-0251-06	Planenhalter	320 mm		1,60
HW-KS-0019-02	Auflagegurt	Länge 5000 mm Breite 50 mm	mit Rundring	
HF-ARC-0427-04	Spiegel	20 x 2594 mm	S235	6,40
HF-ARC-0485-05	Planenkurbel	Ø 50 mm	verzinkt	1,30

10 Planen / Zubehör

3

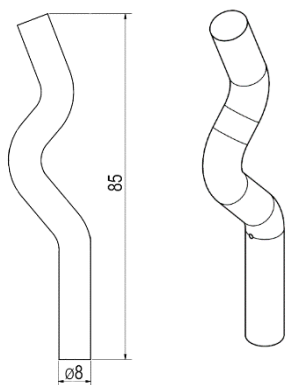

HF-ARC-0164-01

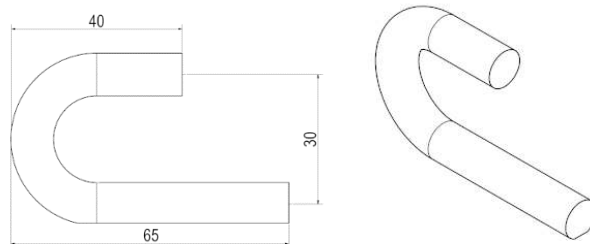

HF-ARC-0164-02

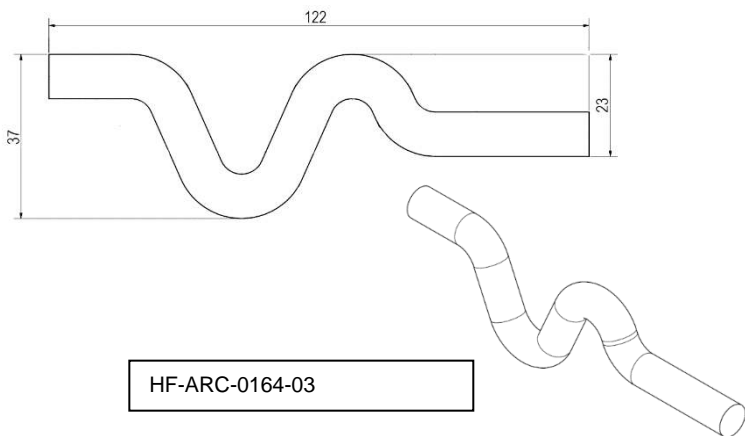

HF-ARC-0164-03

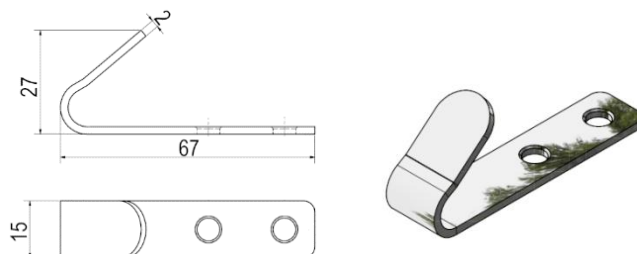

HW-MT-0083-01

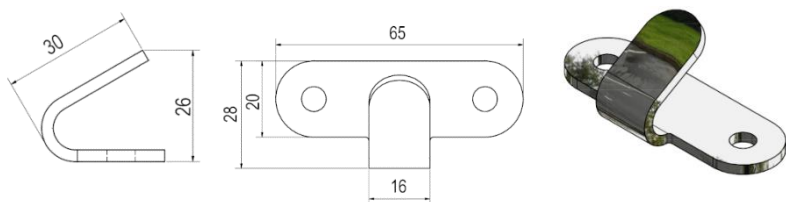

HW-MT-0083-02

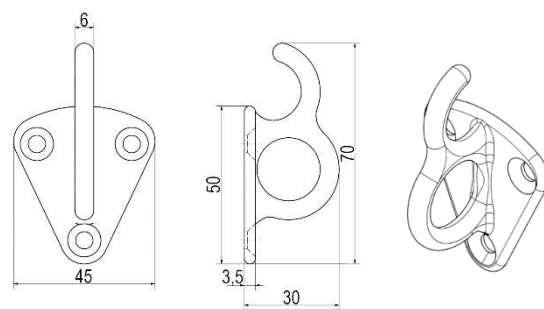

HW-MT-0083-03

Zeich.-Nr.	Bezeichnung	Abmessung	Bemerkung	Gewicht/ Kg
HF-ARC-0164-01	Netzhaken	Ø 8 mm Länge 90 mm		0,03
HF-ARC-0164-02	Netzhaken	Ø 10 mm Länge 112 mm		0,10
HF-ARC-0164-03	Netzhaken	Ø 10 mm Länge 160 mm		0,10
HW-MT-0083-01	Netzhaken	Länge 67 mm		0,10
HW-MT-0083-02	Netzhaken	Länge 65 mm		0,10
HW-MT-0083-03	Netzhaken	Länge 70 mm		0,10